

tapflo®

TAPFLO SOLUTIONS™

2020 | 1

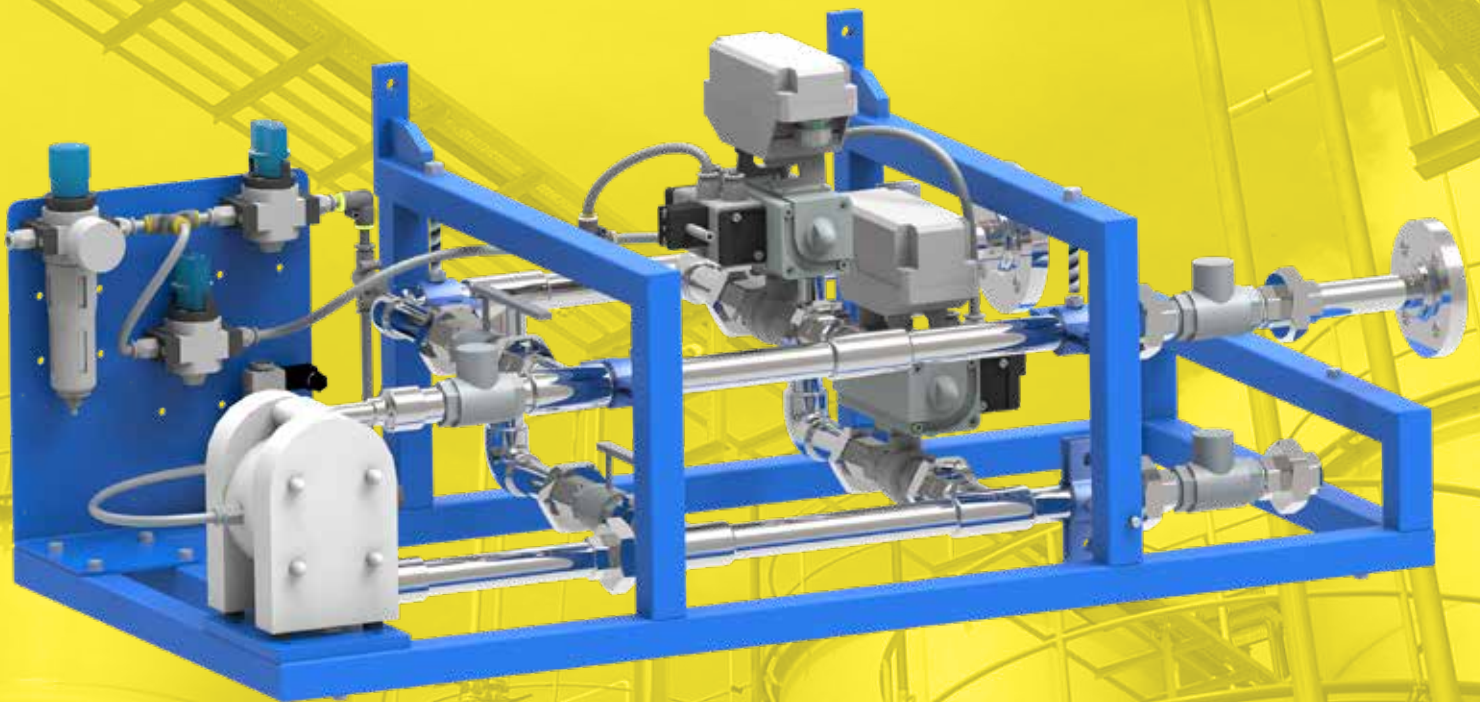

» All about your flow™

www.tapflo.com

» All about your flow™

We began our journey 40 years ago in Kungälv, a small town on the Swedish west coast, as a family company with an ambition to one day become a global player on the pump market.

Since 1980, we have taken pride in delivering a wealth of knowledge and passion for pumps to the industry, whilst supplying a wide range of premium products for various industrial applications.

Over the years, the company has developed into a global Tapflo Group with branches and distributors present in nearly every region of the world.

One thing did not change - we are still a family company.

Our solutions are designed and manufactured in Europe and distributed globally to offer the best service and flow solutions to our customers for a variety of applications.

Our values, Commitment, Quality and Simplicity are reflected both in our product and business approach.



For fast and flexible service and high-quality products readily available worldwide, choose Tapflo.

Quality commitment

At Tapflo we are simply committed to quality. As a result, our production standards, as well as products quality, comply with various globally recognised certification and quality control standards. The Tapflo manufacturing process is certified according to ISO 9001:2015, confirming that our processes are appropriate, effective, customer-focused and continuously improved.



Tapflo values

Our culture is concluded in Our values

Commitment

We are different from our competitors because of our willingness to exceed the customers' expectations, move fast and be flexible. Our culture is based on the spirit of togetherness, enthusiasm and integrity. We come from all over the world but we share the same values and we respect each other. We are committed.

Quality

We understand that the quality in our work is never better than the weakest link, that's why we focus on every small detail. We share a common passion for continuously finding more efficient and effective ways to provide value to our customers. As a manufacturer we have control of the complete process both in terms of our products and the way we operate internally. That is why we manufacture the highest quality pumps in our segment.

Simplicity

We have a saying, "Simple is art" which means we try to find smooth and uncomplicated solutions in everything. By keeping it simple we can focus on the essential, like designing uncomplicated pumps with few components. For us it is a key to success; strive to simplify what is complex.

Customised Flow Systems

Reliability and safety are found as the most desired characteristics of devices applied in industrial processes. To meet customers' need, Tapflo offers tailor-made flow systems of the highest quality.

Our mission is to provide technical solutions that guarantee proper functionality and stable operation in every environment.

Tapflo solutions are successfully applied in the following applications:

Industrial sector:

- Chemical processing industry
- Oil & Gas
- Mechanical industry
- Surface treatment
- Pulp & paper industry
- Paint, print & varnish industry
- Waste water treatment



Hygienic & sanitary sector:

- Food, beverages & drinks
- Dairy, milk & ice cream
- Pharmaceutical industry
- Cosmetics industry
- Processed food



Tapflo Integrated Solutions

Tapflo offers integrated solutions as an possibility to apply standard devices in non-standard applications.

Combining different flow components into one complex unit is an opportunity to suit individual customers' needs, that are related to:

- » Required equipment & functionality
- » Available space
- » Position of connecting flanges
- » Mobility

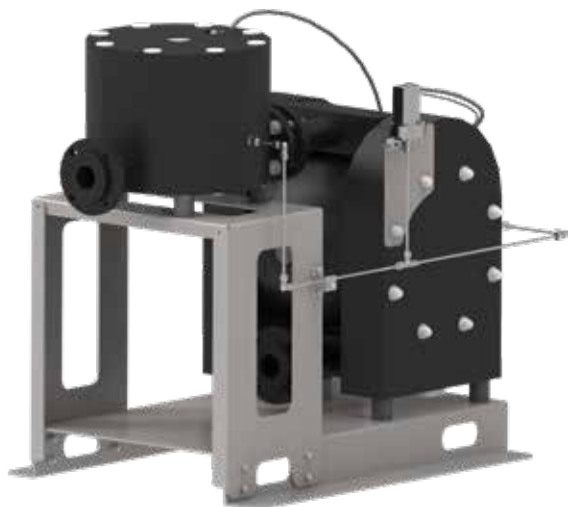

■ **TXB400+DTBX400:**
integrated with pneumatic Diaphragm Failure Monitoring System (PDFM).



■ **T225+DT225:**
integrated with air pressure booster, built on a hygienic frame.

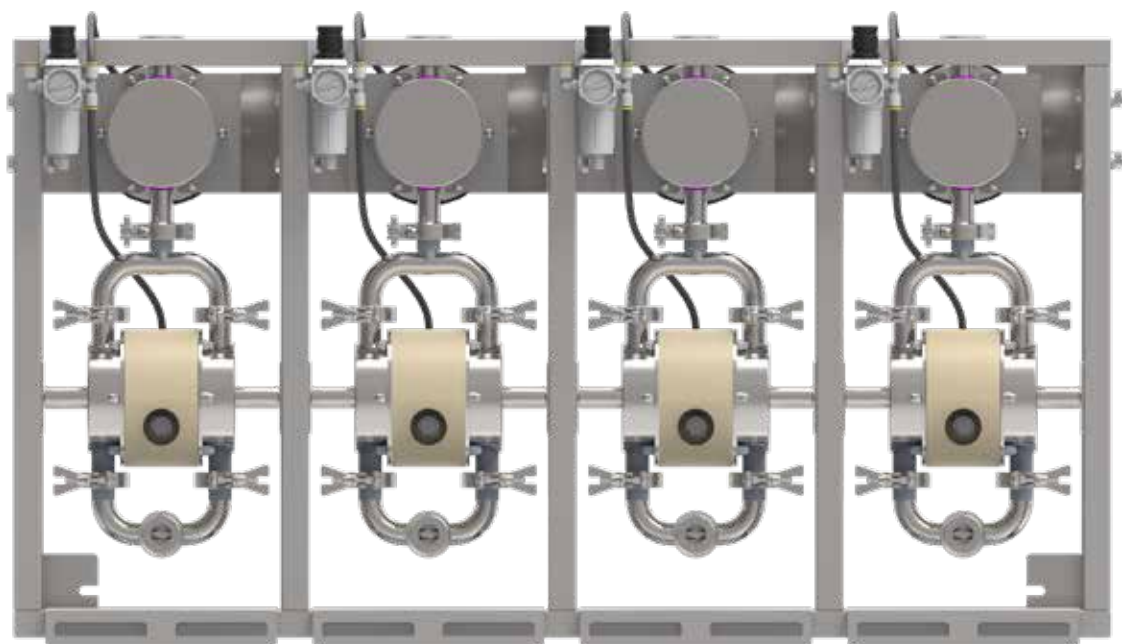

■ **4x T80+DT80:**
assembled on a hygienic frame with removable drip pans.

Tapflo Integrated Solutions



Tapflo biggest pumps & dampeners now available as integrated units!



■ **T800+DT800 & T820+DT820:** built on one support frame with footprint reduced to less than 0,6 m²!

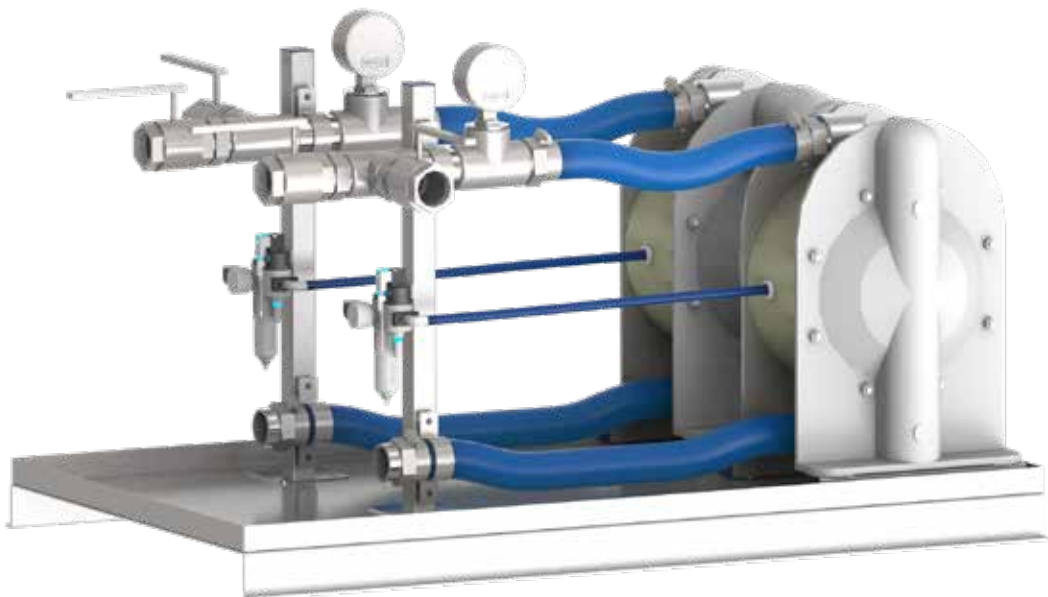

■ **2xT420:**
Compact assembly on a support frame with a drip pan.
Ball valves and pressure indicators included to meet customer's needs.

SKID - Customised Process Units

Main elements of Tapflo pumping SKID

Every need for a non-standard pumping system is an opportunity for us to create a unique, made-to-measure SKID.

Tapflo Engineering to Order team has developed a complex unloading solution, that is successfully used to unload barrels containing various chemicals. Tapflo AODD pump is a heart of this process.

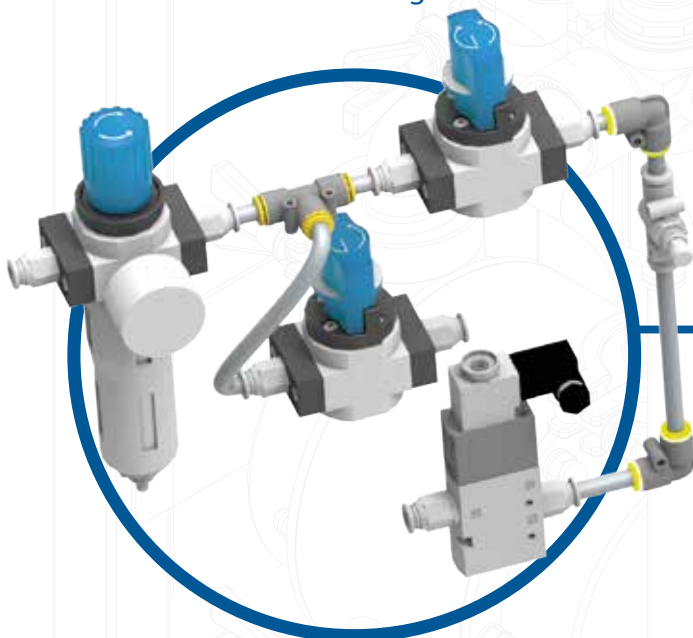

Pneumatic or electric control system:

To optimize the process and have control over it. The pump is stopped after each barrel is emptied. After that the pipelines are flushed with water.



Tapflo pump:

It is the heart of Your process. Tapflo AODD pumps can handle almost every liquid.

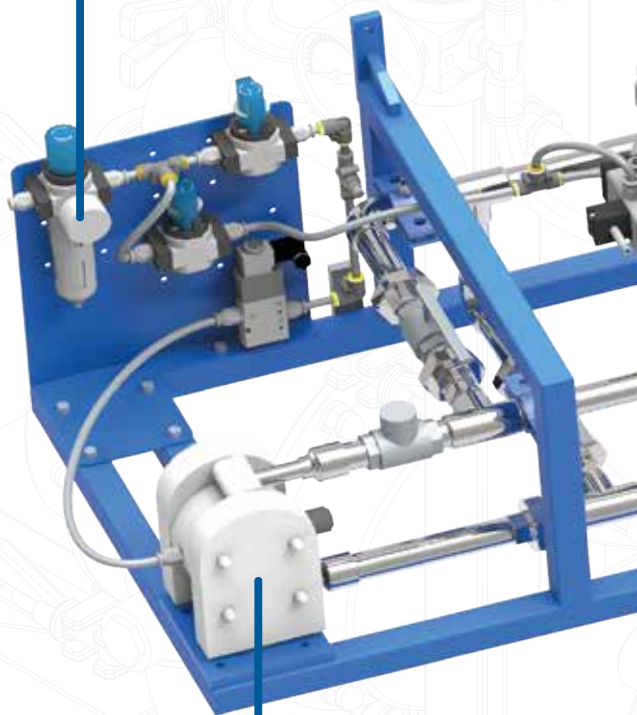

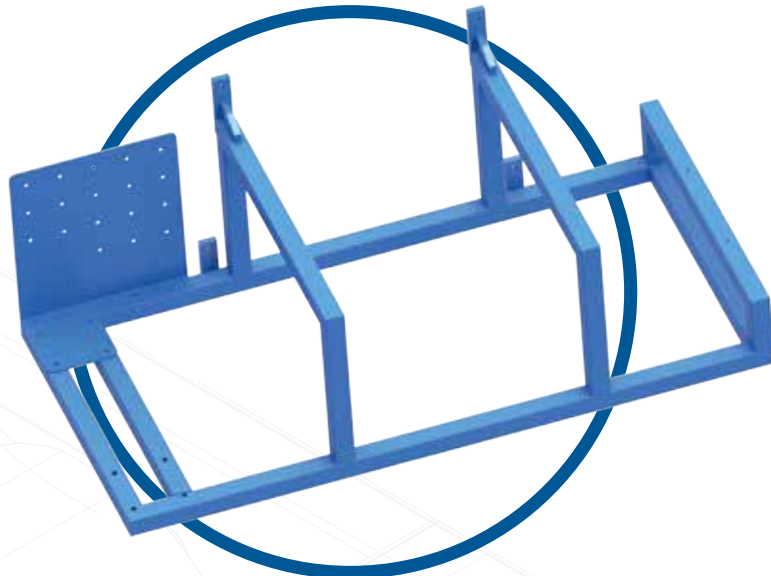

Support frame:

To keep the unit steadily and fit it to available space. Both industrial & hygienic standards are available.

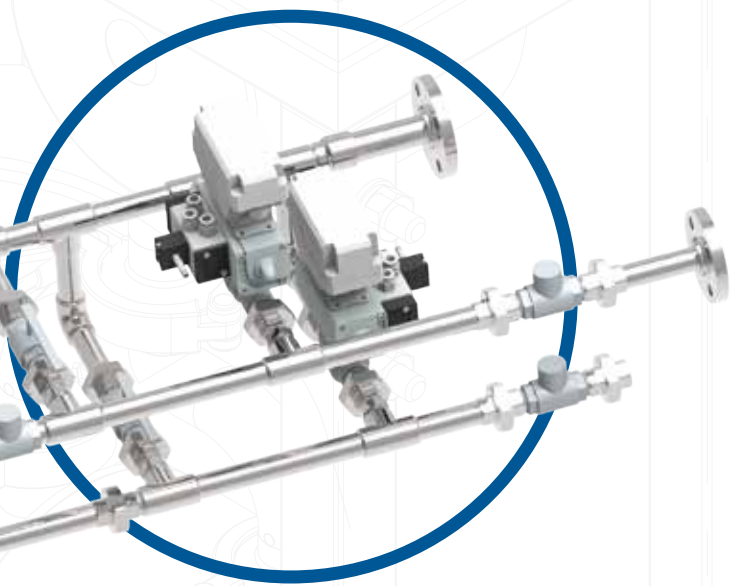
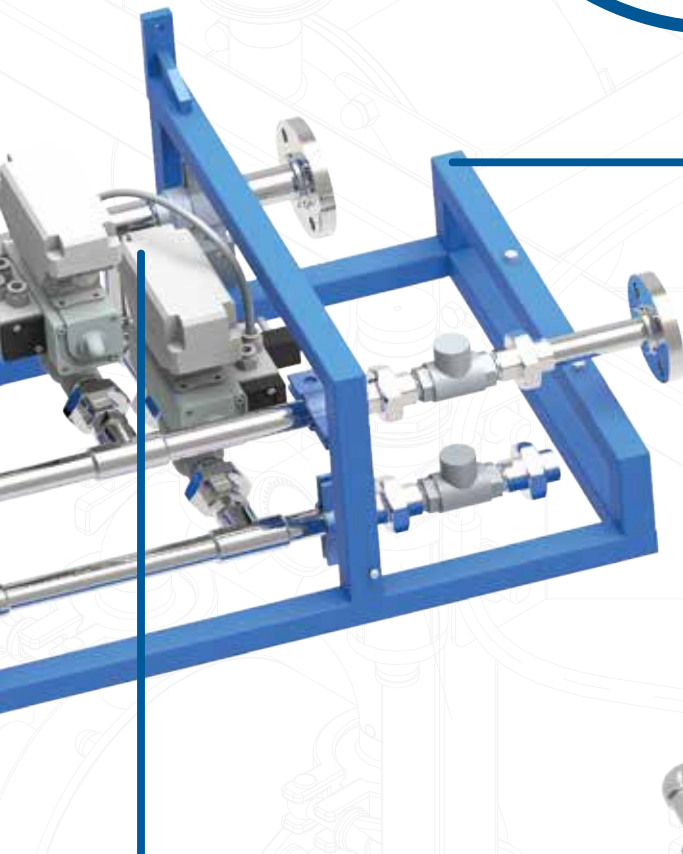

Control valves & pipelines:

As we care about proper flow properties, pipelines in every SKID unit are being analyzed and adjusted to obtain the best possible hydraulic conditions.

SKID - Customised Process Units

Sample solutions

Based on strong experience in design and production, Tapflo offers wide range of compact process pumping systems.

We create units that are dedicated to certain applications in certain industrial sectors. In Tapflo we provide almost limitless possibilities of pump units' development, both in mechanical & automation disciplines.

In addition, Tapflo might take responsibility for project management, assembly works and integration with existing on site systems.

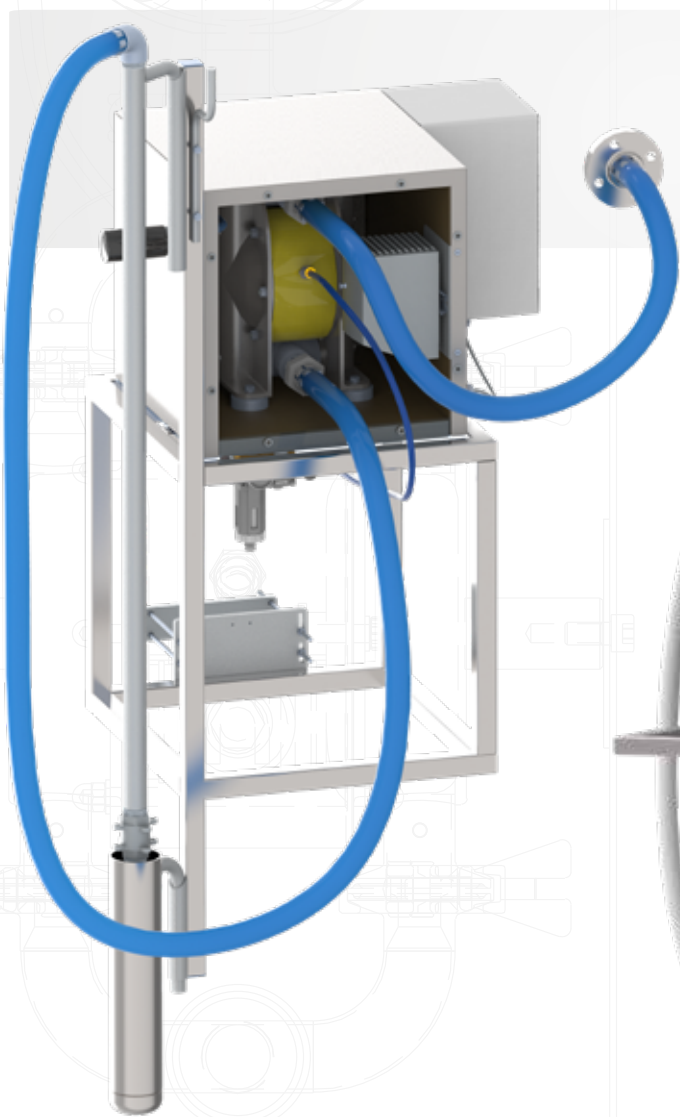

■ **IBC containers unloading unit**
Including **Tapflo T120** pump built in a temperature proof box with a control panel. Ready to work in low ambient temperatures.



"WE WORK IN A TURN-KEY STANDARD"



■ **Mobile mixing & unloading tank**
Tapflo CTV 40-13.5 pump to operate in paint industry.

SKID - Customised Process Units

Sample solutions



**"TAPFLO BRINGS
FUNCTIONALITY"**

■ Ethanol dispensing and filtering unit:

Tapflo TRX20 pump unloading
a container at pharmaceutical
factory. ATEX-approved unit.

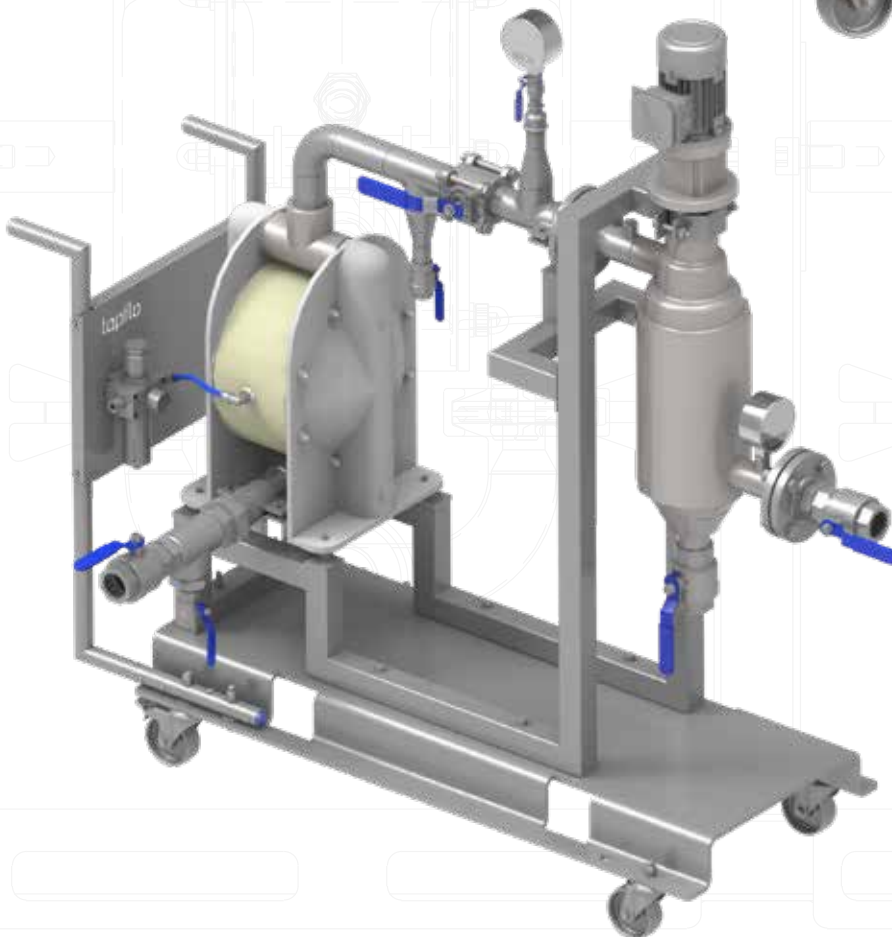

■ Mobile filtration unit:

Tapflo T420 pump supplying
paint resin through a self-
cleaning filter.

Tapflo Automation & Control Solutions

Tapflo is proud to announce, that we have broadened our offer with automation & control solutions.

By using both pneumatic and electric devices to monitor flow parameters, we are able to ensure safe work of all Tapflo pump units.

» Air Operated Double Diaphragm Pumps



■ Pneumatic Diaphragm Failure Monitoring System (PDFM)



■ Pneumatic Dry-Run & Dead Head Protection Systems (PDRN, PDHR, PDHS)



■ Electronic Dry Run & Dead Head protection system (EDHR)

» Centrifugal Pumps

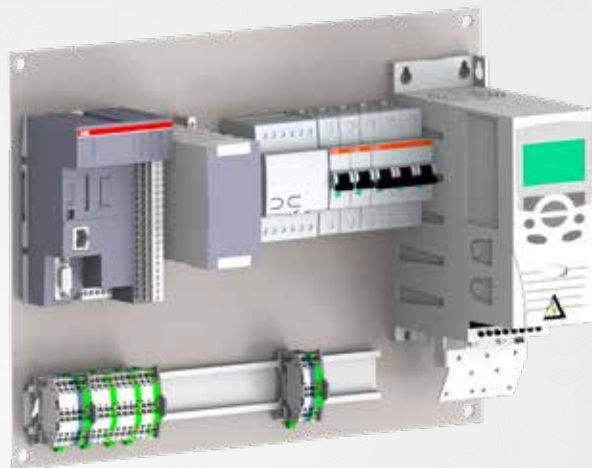











Stainless and painted steel control cabinets available!

- » Built-in frequency inverter
- » Start & stop pushbuttons
- » Main switch: padlockable in OFF position for service purpose
- » Configured according to customer's guidelines

Product range

Diaphragm pumps & accessories

<p>NEW</p>  <p>Electrically operated pumps</p>	 <p>PE & PTFE pumps</p>	 <p>Metal pumps</p>	 <p>Pharmaceutical pumps</p>	 <p>Sanitary pumps</p>
 <p>TC Intelligent pumps</p>	 <p>Powder pumps</p>	 <p>TF Filter press pumps</p>	<p>NEW</p>  <p>Steinle filter press pumps</p>	 <p>EHEDG aseptic pumps</p>

Peristaltic Pumps

 <p>Active pulsation dampeners</p>	 <p>Systems & accessories</p>	 <p>Trolleys</p>	 <p>PT pumps</p>	 <p>PTL pumps</p>
--	---	--	---	---

Centrifugal pumps, filter units & accessories

 <p>CTI & CTH centrifugal pumps</p>	 <p>CTS self-priming centrifugal pumps</p>	 <p>CTV vertical centrifugal pumps</p>	 <p>CTP plastic centrifugal pumps</p>
 <p>CTM magnetic drive centrifugal pumps</p>	 <p>Trolleys</p>	 <p>FT Filter units</p>	

Sweden

Filaregatan 4 | S-442 34 Kungälv

Tel: +46 303 63390

Fax: +46 303 19916

E-mail addresses:

Commercial questions: sales@tapflo.com

Orders: order@tapflo.com

Tech support: support@tapflo.com

Tapflo products and services are available in 75 countries on 6 continents.

Tapflo is represented worldwide by own Tapflo Group Companies and carefully selected distributors assuring highest Tapflo service quality for our customers' convenience.

AUSTRALIA | AUSTRIA | AZERBAIJAN | BAHRAIN | BELARUS | BELGIUM | BOSNIA | BRAZIL | BULGARIA | CANADA | CHILE | CHINA | COLOMBIA | CROATIA | CZECH REPUBLIC | DENMARK | ECUADOR | EGYPT | ESTONIA | FINLAND | FRANCE | GREECE | GEORGIA | GERMANY | HONG-KONG | HUNGARY | ICELAND | INDIA | INDONESIA | IRAN | IRELAND | ISRAEL | ITALY | JAPAN | JORDAN | KAZAKHSTAN | KUWAIT | LATVIA | LIBYA | LITHUANIA | MACEDONIA | MALAYSIA | MEXICO | MONTENEGRO | MOROCCO | NETHERLANDS | NEW ZEALAND | NORWAY | POLAND | PORTUGAL | PHILIPPINES | QATAR | ROMANIA | RUSSIA | SAUDI ARABIA | SERBIA | SINGAPORE | SLOVAKIA | SLOVENIA | SOUTH AFRICA | SOUTH KOREA | SPAIN | SUDAN | SWEDEN | SWITZERLAND | SYRIA | TAIWAN | THAILAND | TURKEY | UKRAINE | UNITED ARAB EMIRATES | UNITED KINGDOM | USA | UZBEKISTAN | VIETNAM

Tapflo Group Companies

Australia

Tapflo Oceania (Pty)
Tel: +61 1800 303 633
sales@tapflo.com.au

Austria

Tapflo Austria
Tel: +43 732 27292910
sales@tapflo.at

Baltic States

Tapflo Latvia
Tel: +371 67472205
sales@tapflo.lv

Belarus

Tapflo Belarus
Tel: +375 17 3934609
sales@tapflo.by

Belgium

Tapflo Benelux B.V.
Tel: +31 (0)85 00 743 00
info@tapflo.nl

Bulgaria

Tapflo EOOD
Tel: +359 (0)2 974 18 54
office@tapflo.bg

Canada

Tapflo Canada
Tel: +1 514 813 5754
canada@tapflo.com

Croatia

Tapflo GmbH
Tel: +385 91 4884 666
sales@tapflo.hr

Czech Republic

Tapflo s.r.o.
Tel: +420 513 033 924
tapflo@tapflo.cz

China

Tapflo (Wuxi)
Tel: +86 510 8241 7072
sales@tapflo.cn

Denmark

Tapflo Danmark
Tel: +45 36 454600
info@tapflo.dk

France

Tapflo France
Tel: +33 1 34 78 82 40
info@tapflo.fr

India

Tapflo Fluid Handling India Pvt Ltd
Tel: +91 20 65000215
ac@tapflo.in

Ireland

Tapflo Ireland Ltd
Tel: +353 1 2011911
info@tapflo.ie

Italy

Tapflo Italia
Tel: +39 0362 306528
info@tapfloitalia.com

Japan

Tapflo Japan K.K.
Tel: +81-3-6240-3510
tapflojp@tapflo.co.jp

Kazakhstan

Tapflo Kazakhstan
Tel: +7 727 3278347
sales@tapflo.kz

Netherlands

Tapflo Benelux B.V.
Tel: +31 (0)85 00 743 00
info@tapflo.nl

Poland

Tapflo Sp. z o.o.
Tel: +48 58 530 42 12
info@tapflo.pl

Romania

S.C. Tapflo Rom. S.r.l.
Tel: +40 21 3451255
sales@tapflo.ro

Russia

Tapflo Company
Tel: +7 495 232 18 28
sales@tapflo.com.ru

Serbia

Tapflo d.o.o.
Tel: +381 21 44 58 08
sales@tapflo.rs

Slovakia

Tapflo s.r.o.
Tel: +421 911 137 883
tapflo@tapflo.sk

Slovenia

Tapflo GmbH
Tel: +386 68 613 474
sales@tapflo.hr

Spain

Tapflo Iberica
Tel: +34 91 8093182
avives@tapfloiberica.es

South Africa

Tapflo (Pty) Ltd
Tel: +27 31 701 5255
sales@tapflo.co.za

Turkey

Tapflo Makina Ltd
Tel: +90 216 467 33 11
sales@tapflo.com.tr

Ukraine

TOB Tapflo
Tel: +380 44 222 68 44
sales@tapflo.ua

Uzbekistan

Tapflo Uzbekistan
Tel: +998 712370940
sales@tapflo.uz

United Kingdom

Tapflo (UK) Ltd
Tel: +44 2380 252325
sales@tapflo pumps.co.uk